

Article number: 230100044111  
 Description: E+G Crank handle  
 MT.64 AS-8x8-SI

## Measures

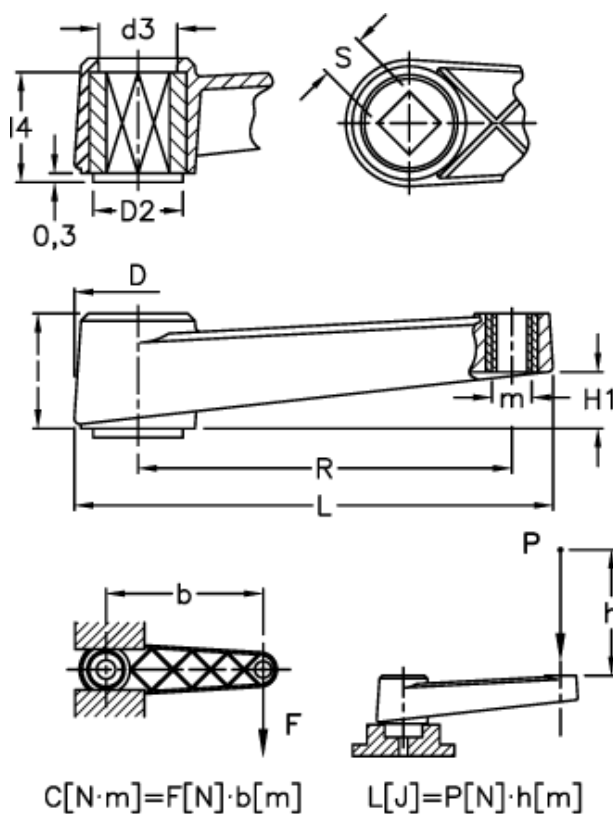

C (N m)	= 120	l4	= 19
D	= 27	m	= M6
d2	= 18	R	= 64
d3	= 16	S H9	= 8x8
H1	= 10		
l	= 23		
L	= 86		
L(J)	= 11		